

ST 010 108 7811



- sporgenza 167 mm
- bocca fissa
- Getto squadrato con aria
- altezza rubinetteria 198 mm
- altezza fino al rompigitto 133 mm
- diametro foro rubinetteria 35 mm
- diametro foro piletta 32 mm
- manopola Ø 60mm
- 2x tubo flessibile di mandata M 8 x 1 avvitato, tenuta controllata
- 1x tubo flessibile di mandata M 10 x 1 avvitato, tenuta controllata
- portata max 4,5 l/min
- Cartuccia innovativa
- senza piombo
- con contrassegno caldo / freddo
- Questo prodotto può aiutare un edificio a soddisfare i requisiti dei Green Building Rating Systems, ad es. LEED®, BREEAM®, DGNB

	Cromato	ST 010 108 7811-00
	Platinato spazzolato	ST 010 108 7811-06
	Dark Chrome	ST 010 108 7811-19
	Ottone spazzolato (Oro 23k)	ST 010 108 7811-28
	platinato / platinato opaco	ST 010 108 7811-36
	Ottone / Ottone spazzolato (Oro 23k)	ST 010 108 7811-38
	Dark Platinum spazzolato	ST 010 108 7811-99

Componenti singoli di questo set

Per questo set sono necessari i seguenti componenti

1x 29 218 811-00



1x 11 188 811-00



ST 010 108 7811



- sporgenza 167 mm
- bocca fissa
- Getto squadrato con aria
- altezza rubinetteria 198 mm
- altezza fino al rompigitto 133 mm
- diametro foro rubinetteria 35 mm
- diametro foro piletta 32 mm
- manopola Ø 60mm
- 2x tubo flessibile di mandata M 8 x 1 avvitato, tenuta controllata
- 1x tubo flessibile di mandata M 10 x 1 avvitato, tenuta controllata
- portata max 4,5 l/min
- Cartuccia innovativa
- senza piombo
- Questo prodotto può aiutare un edificio a soddisfare i requisiti dei Green Building Rating Systems, ad es. LEED®, BREEAM®, DGNB

ATTENZIONE: Gli inserti maniglia devono essere ordinati separatamente per i raccordi!

	Cromato	29 218 811-00
	Platinato spazzolato	29 218 811-06
	Dark Chrome	29 218 811-19
	Ottone spazzolato (Oro 23k)	29 218 811-28
	platinato / platinato opaco	29 218 811-36
	Ottone / Ottone spazzolato (Oro 23k)	29 218 811-38
	Dark Platinum spazzolato	29 218 811-99

ST 010 108 7811



Diagramma di portata



Certificati

WRAS_2201012. LGA_38103.

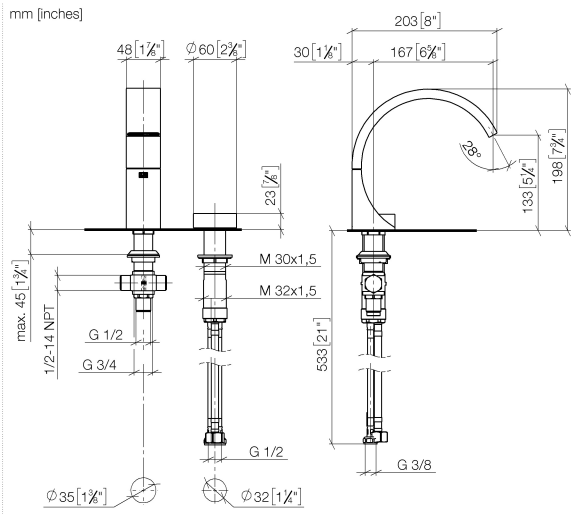
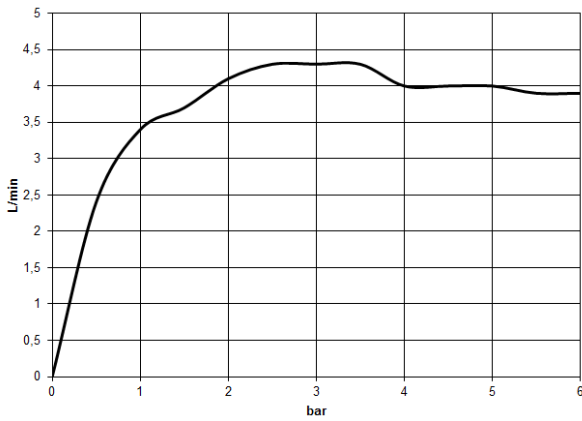
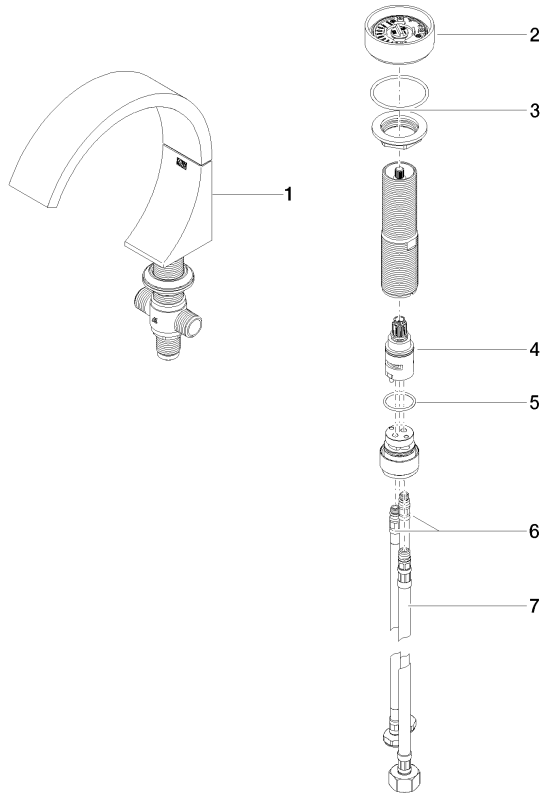







Elenco delle parti di ricambio

N.	Codice articolo	Denominazione	Quantità necessaria	Tempo di produzione
1	13 717 811-00	CYO Bocca lavabo da piano senza piletta - Cromato	1	10
2	90 18 40 290 00-00	manopola	1	10
3	04 30 11 038 67 90	set di fissaggio	1	2
4	90 90 03 169 00 90	parte superiore	1	2
5	09 14 10 112 90	guarnizione	1	2
6	04 30 04 100 00 90	flessibile	2	2
7	04 30 04 019 00 90	flessibile	1	2

ST 010 108 7811



- con contrassegno caldo / freddo
- per miscelatore monocomando a due fori per lavabo

	Cromato	11 188 811-00
	Platinato spazzolato	11 188 811-06
	Platinato	11 188 811-08
	Ottone (Oro 23k)	11 188 811-09
	Dark Chrome	11 188 811-19
	Ottone spazzolato (Oro 23k)	11 188 811-28
	Dark Platinum spazzolato	11 188 811-99

ST 010 108 7811

mm [inches]

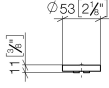

ST 010 108 7811

Parts for other
finishes can be found
here: Platinato
spazzolato

